

---

# User Manual

Three-phase Microinverter HMT-1800/2250

## About Microinverter

This system is composed of a group of Three-Phase Microinverters that convert direct current (DC) into alternating current (AC) and feeds it into the public grid. The system is designed for the incorporation of one Microinverter for six photovoltaic modules.

Each Microinverter works independently that guarantees the maximum power generation of each photovoltaic module. This setup enables user to control the production of a single photovoltaic module directly, consequently improving the flexibility and reliability of the system.

## About the Manual

This manual contains important instructions for the HMT-1800/HMT-2250 Microinverter and must be read in its entirety before installing or commissioning the equipment.

For safety, only qualified technician, who has received training or has demonstrated skills can install and maintain this Microinverter under the guide of this document.

## Other Information

Product information is subject to change without notice. User manual will be updated frequently, please refer to Hoymiles official website at [www.hoymiles.com](http://www.hoymiles.com) for the latest version.

# CONTENTS

<b>1. Important Notes</b>	<b>03</b>
1.1 Product Range	03
1.2 Microinverter Accessories	03
1.3 Target Group	03
1.4 Symbols Used	03
1.5 Radio Interference Statement	03
<b>2. About Safety</b>	<b>04</b>
2.1 Important Safety Instructions	04
2.2 Explanation of Symbols	05
<b>3. About Product</b>	<b>06</b>
3.1 About Three-Phase Microinverter	06
3.2 About Sub-1G technology	06
3.3 Highlights	06
3.4 Terminals Introduction	07
3.5 Dimension(mm)	07
<b>4. Installation Preparation</b>	<b>08</b>
4.1 Module Compatibility	08
4.2 AC Branch Circuit Capacity	08
4.3 Position and Space Required	08
4.4 Grounding Consideration	08
<b>5. Microinverter Installation</b>	<b>09</b>
5.1 Accessories	09
5.2 Pre-installation	09
5.3 Installation Steps	10
<b>6. Troubleshooting</b>	<b>12</b>
6.1 Troubleshooting List	12
6.2 Status LED Indicator	16
6.3 On-site Inspection (For qualified installer only)	17
6.4 Routine Maintenance	17
6.5 Replace Microinverter	18
<b>7. Decommissions</b>	<b>19</b>
7.1 Decommissions	19
7.2 Storage and Transportation	19
7.3 Disposal	19
<b>8. Technical Data</b>	<b>20</b>
8.1 DC Input	20
8.2 AC Output	20
8.3 Efficiency, Safety and Protection	21
8.4 Mechanical Data	21
8.5 Features	21
<b>Appendix 1:</b>	<b>22</b>
Installation Map	22
<b>Appendix 2:</b>	<b>23</b>
WIRING DIAGRAM – 230VAC / 400VAC THREE PHASE:	23

# 1. Important Notes

## 1.1 Product Range

This manual describes the assembly, installation, commissioning, maintenance and failure search of the following model of Hoymiles Three-Phase Microinverter:

- HMT-1800-6T
- HMT-2250-6T

*\*Note: "1800" means 1800W, "2250" means 2250W.*

## 1.2 Microinverter Accessories

Hoymiles HMT series three-phase microinverter need to be used with the special three-phase system accessories, including three-phase bus cable, unlock tool, end cap, etc. Please find more information in chapter 4.1.



A DTU is required if the user wants to see the information and solar production on Hoymiles Monitoring System.

## 1.3 Target Group

This manual is only for qualified technician, who has been trained or has demonstrated skills can install and maintain this Microinverter under the guide of this document for safety purpose.

## 1.4 Symbols Used

The safety symbols in this user manual are show as below.

Symbol	Usage
	Indicates a hazardous situation that can result in deadly electric shock hazards, other serious physical injury, or fire hazards.
	Indicates directions which must be fully understood and followed in entirety in order to avoid potential safety hazards including equipment damage or personal injury.
	Indicates this points out that the described operation must not be carried out. The reader should stop, use caution and fully understand the operations explained before proceeding.

## 1.5 Radio Interference Statement

This microinverter has been tested and found to comply with the limits for CE EMC, which can provide reasonable protection against harmful energy. However, if not installed according to the instructions, the microinverter may cause harmful interference to radio equipment. There is no guarantee that the interference will not occur in a particular installation.

To confirm that the radio or television reception is interfered by this equipment, you can turn the equipment off and on. If this equipment does cause harmful interference to the radio or television equipment, please try to correct the interference by one or more of the following measures:

- 1) Relocate the receiving antenna.
- 2) Increase the separation between the microinverter and the receiving antenna.
- 3) Place the shield between the microinverter and the receiving antenna, such as metal / concrete roof.
- 4) Contact your dealer or an experienced radio/TV technician for help.







## 2. About Safety

### 2.1 Important Safety Instructions

The HMT-1800/HMT-2250 Three-Phase Microinverter is designed and tested according to international safety requirements. However, certain safety precautions must be taken when installing and operating this inverter. The installer must read and follow all instructions, cautions and warnings in this installation manual.

<ul style="list-style-type: none"> <li>All operations including transport, installation, start-up and maintenance, must be carried out by qualified, trained personnel.</li> </ul>
<ul style="list-style-type: none"> <li>Before installation, check the unit to ensure free of any transport or handling damage, which could affect insulation integrity or safety clearances. Choose installation location carefully and adhere to specified cooling requirements. Unauthorized removal of necessary protections, improper use, incorrect installation and operation may lead to serious safety and shock hazards or equipment damage.</li> </ul>
<ul style="list-style-type: none"> <li>Before connecting the Microinverter to the power distribution grid, contact the local power distribution grid company to get appropriate approvals. This connection must be made only by qualified technical personnel. It is the responsibility of the installer to provide external disconnect switches and Over current Protection Devices (OCPD).</li> </ul>
<ul style="list-style-type: none"> <li>Usually only one photovoltaic module can be connected to one input of the inverter. Do not connect batteries or other sources of power supply. The inverter can be used only if all the technical characteristics are observed and applied.</li> </ul>
<ul style="list-style-type: none"> <li>Do not install the equipment in adverse environment conditions such as flammable, explosive, corrosive, extreme high or low temperature, and humid. Do not use the equipment when the safety devices do not work or disabled.</li> </ul>
<ul style="list-style-type: none"> <li>Use personal protective equipment, including gloves and eye protection during the installation.</li> </ul>
<ul style="list-style-type: none"> <li>Inform the manufacturer about non-standard installation conditions.</li> </ul>
<ul style="list-style-type: none"> <li>Do not use the equipment if any operating anomalies are found. Avoid temporary repairs.</li> </ul>
<ul style="list-style-type: none"> <li>All repairs should be carried out using only qualified spare parts, which must be installed in accordance with their intended use and by a licensed contractor or authorized Hoymiles service representative.</li> </ul>
<ul style="list-style-type: none"> <li>Liabilities arising from commercial components are delegated to their respective manufacturers.</li> </ul>
<ul style="list-style-type: none"> <li>Anytime the inverter has been disconnected from the public network, please be extremely caution as some components can retain charge sufficient to create a shock hazard. Prior to touching any part of the inverter please ensure surfaces and equipment are under touch safe temperatures and voltage potentials before proceeding.</li> </ul>
<ul style="list-style-type: none"> <li>Hoymiles accepts No liability for damage from incorrect or improper operation.</li> </ul>
<ul style="list-style-type: none"> <li>Electrical Installation &amp; Maintenance shall be conducted by licensed electrician and shall comply with Local Wiring Rules.</li> </ul>

## 2.2 Explanation of Symbols

Symbol	Usage
	<p><b>Treatment</b></p> <p>To comply with European Directive 2002/96/EC on waste Electrical and Electronic Equipment and its implementation as national law, electrical equipment that has reached the end of its life must be collected separately and returned to an approved recycling facility. Any device no longer required must be returned to an authorized dealer or approved collection and recycling facility.</p>
	<p><b>Caution</b></p> <p>Do not come within 8 inches (20cm) of the microinverter for any length of time while it is in operation.</p>
	<p><b>Danger of high voltages</b></p> <p>Danger to life due to high voltage in the microinverter.</p>
	<p><b>Beware of hot surface</b></p> <p>The inverter can become hot during operation. Avoid contact with metal surfaces during operation.</p>
	<p><b>CE mark</b></p> <p>The inverter complies with the requirements of the Low Voltage Directive for the European Union.</p>
	<p><b>Read manual first</b></p> <p>Please read the installation manual first before installation, operation and maintenance.</p>

### 3. About Product

#### 3.1 About Three-Phase Microinverter

The world’s first three-phase microinverter with Reactive Power Control, can be widely used in the general 230V/400V three-phase electric power distribution. Each microinverter, with up to 6 PV modules connected, simplifies the installation process and ranks among the most cost effective solutions for commercial and industrial installations.

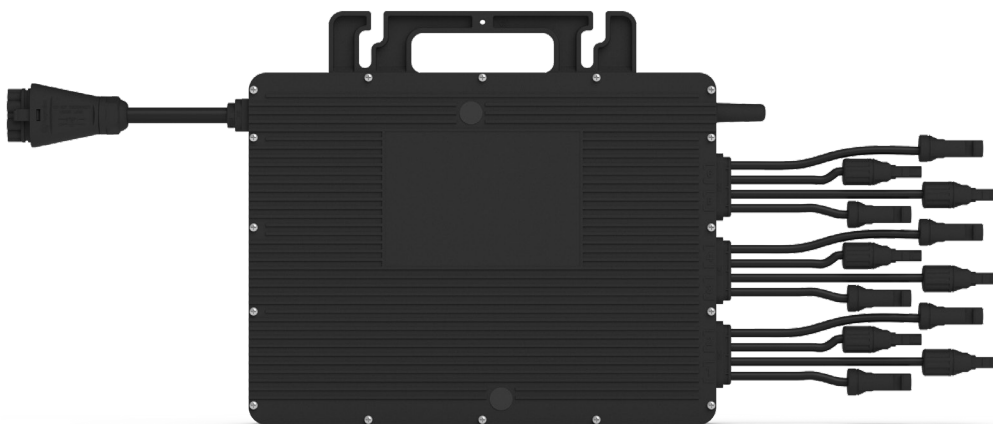

#### 3.2 About Sub-1G technology

Sub-1G technology is particularly useful for PV microinverters and differ from, say, 2.4GHz technologies in that they have substantially larger range and better interference suppression performance.

<b>Range of Sub-1GHz wireless:</b>	Unlike WiFi and Zigbee, who both operate on the 2.4 GHz band, Sub-1GHz operates on the 868 MHz or the 915 MHz bands. Usually, Sub-1GHz wireless transmission offers 1.5-2 times more distance coverage than the 2.4Ghz spectrum.
<b>Interference:</b>	Sub-1GHz wireless can handle interference better. This is because they operate on a lower frequency which can communicate better between PV modules and rooftops, and especially useful in an industrial or commercial PV power plant. Thus, the communication between the microinverters and the DTUs will be more stable.
<b>Lower Power Consumption:</b>	Sub-1GHz wireless typically use less power than WiFi or Zigbee.

Because of the long range and better interference suppression performance, Sub-1GHz networking is particularly well-suited to rooftop PV power stations.

#### 3.3 Highlights

- Three-phase output, more suitable for commercial and industrial applications.
- Each microinverter supports up to 6 modules, faster installation and lower cost.
- Up to 2250VA output, adapted to mainstream high-powered PV modules.
- With Reactive Power Control, meets the requirements of EN50549-1:2019, VDE-AR-N 4105:2018, TOR Erzeuger : 2019-12, etc.
- The Sub-1G wireless solution enables the stable communication when installed for commercial and industrial stations.

### 3.4 Terminals Introduction

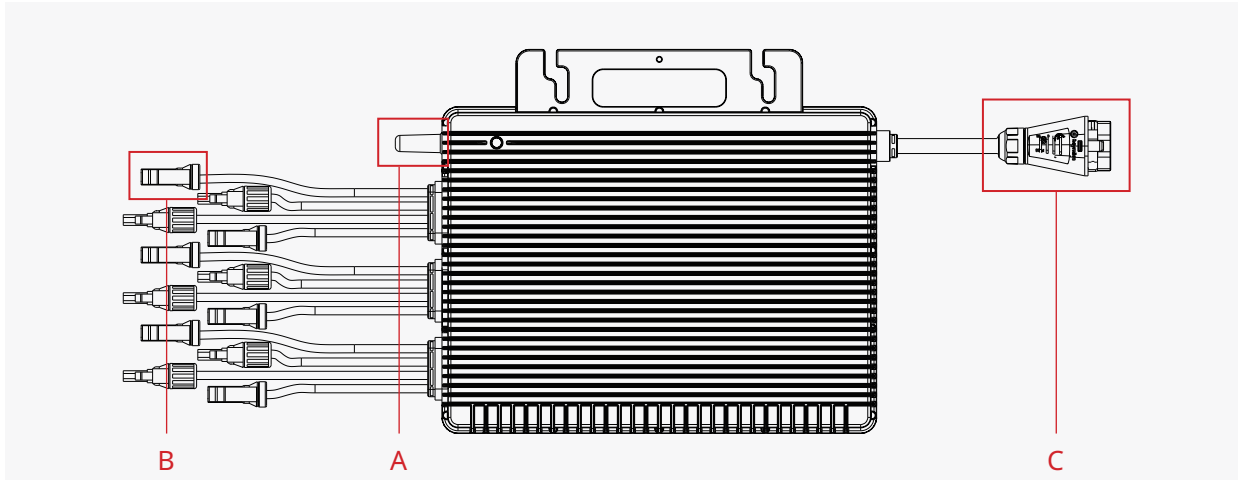

Object	Description
A	Sub-1G Wireless Terminal
B	DC Connectors
C	AC Connector

### 3.5 Dimension(mm)

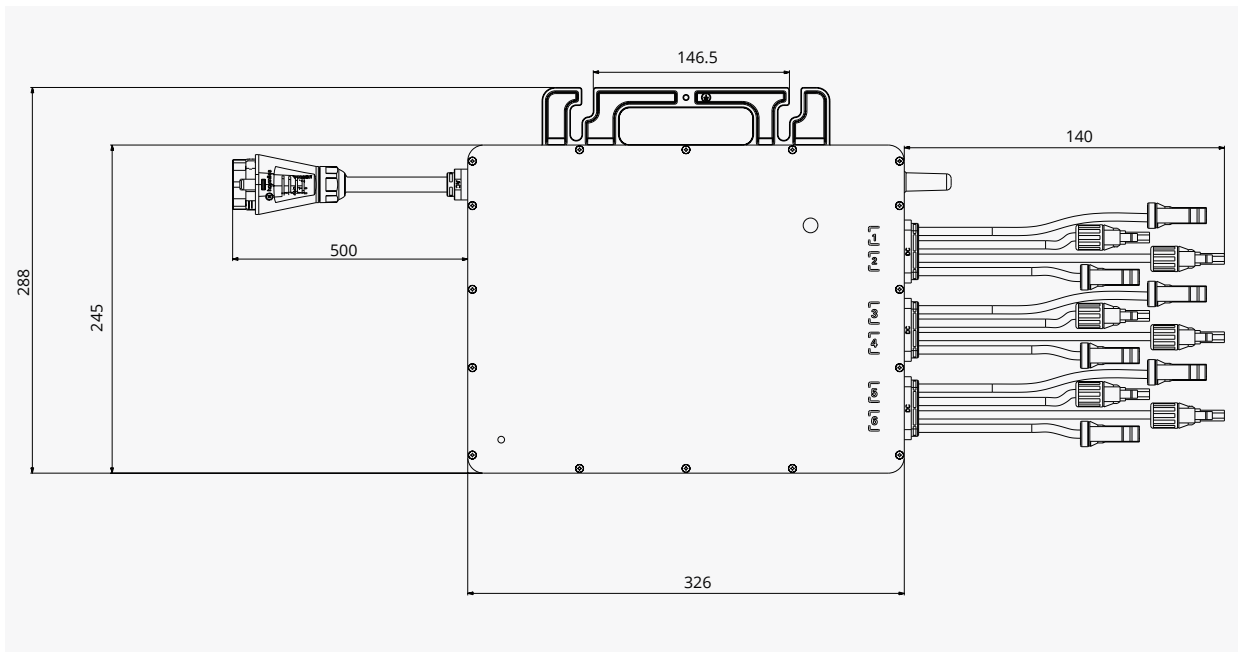



## 4. Installation Preparation

### 4.1 Module Compatibility

Hoymiles HMT series HMT-1800/HMT-2250 are compatible with most 60-cell and 72-cell PV modules. For other types of PV modules, please ensure that they are electrically paired with Hoymiles microinverter. Please see the Technical Data page of this user manual to get more information.

### 4.2 AC Branch Circuit Capacity

Hoymiles HMT-1800/HMT-2250 can be used with 12AWG or 10AWG AC bus cable and the AC bus connector which are provided by Hoymiles. When preparing, do not exceed the limits of maximum number of microinverters per 12AWG or 10AWG AC branch shown as below.

	HMT-1800	HMT-2250	Maximum over current protection device (OCPD)
Maximum number per 12AWG branch	7(@230Vac)	6(@230Vac)	20A
Maximum number per 10AWG branch	11(@230Vac)	9(@230Vac)	30A

### 4.3 Position and Space Required

Please install the Microinverter and all DC connections under the PV module to avoiding direct sunlight, rain exposure, snow layup, UV etc. Also, the silver side of the microinverter should be up and face to the PV module.

Allow a minimum of 2 cm of space around the microinverter enclosure to ensure ventilation and heat dissipation.

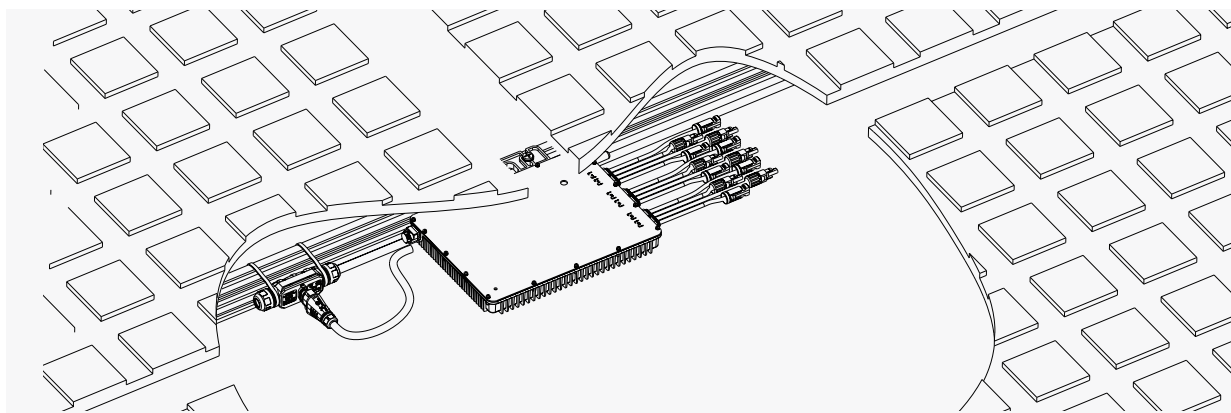

### 4.4 Grounding Consideration

This microinverter is a class I equipment with basic isolation transformer and this microinverter must be earthed. There is an earth wire inside the AC cable, so usually the grounding can be done by directly by this wire. If the utility has some special requirements, the grounding can be done by bonding the mounting bracket to the racking.

## 5. Microinverter Installation

### 5.1 Accessories

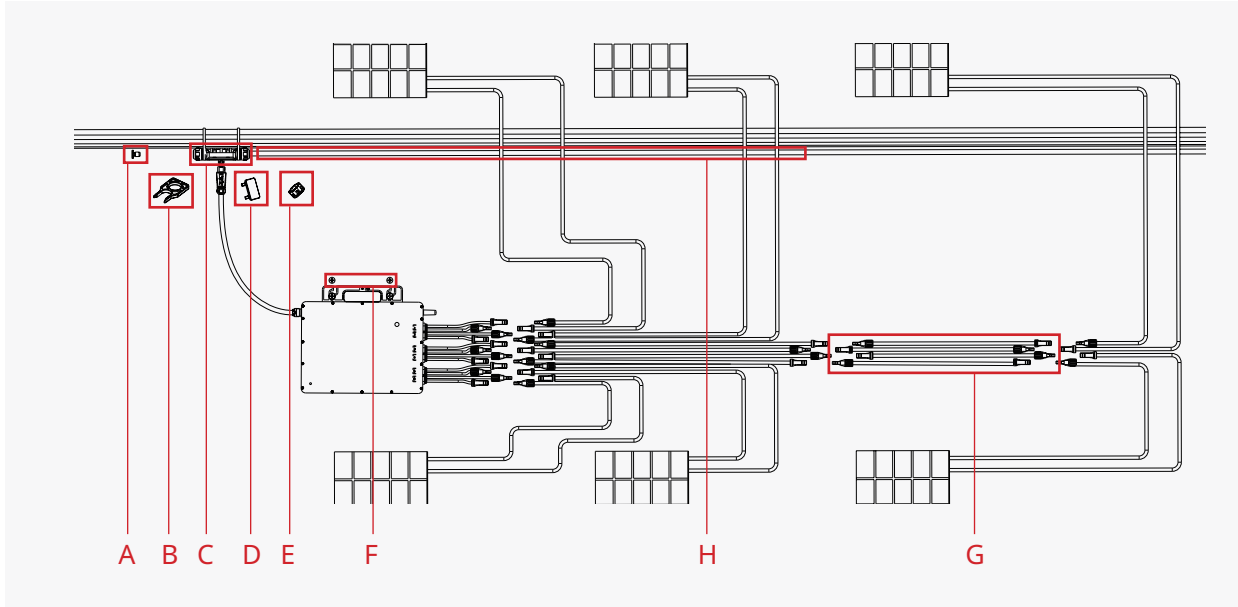

Item	Description
A	3P-AC Bus End Cap, IP67
B	3P-AC Connector Unlock Tool
C	3P-AC Bus Connector
D	3P-Bus Connector Unlock Tool
E	3P-AC Sub Cap
F	M8*25 screws
G	DC Extension Cable,1m
H	3P-AC Bus Cable, 12/10 AWG Optional

\*Note: All accessories above are not included by the package, will need to be purchased separately. Please contact our sales representative for the price (M8 screws will need to be prepared by installer-self).

### 5.2 Pre-installation

- A) Plan the cable length to allow the bus cable align with each PV module.
- B) Install the AC bus end cap:

- Use the 3P-Bus connector unlock tool to unlock the connector upper cover;

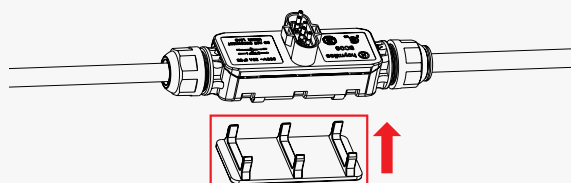

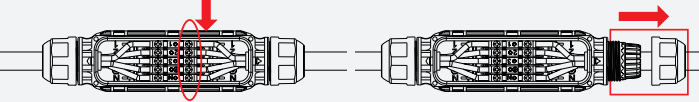
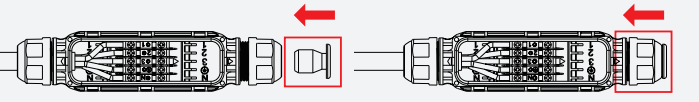
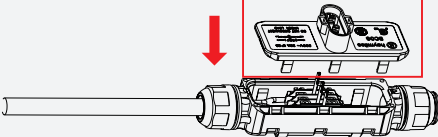
- Loose the five screws with the screwdriver. Untighten the nut shown as picture and remove the extra cable. 
- Slightly screw the nut back to the body, plug in the 3P-AC bus end cap and tighten the nut. 
- Plug the upper cover back to the 3P-AC bus connector. 

### 5.3 Installation Steps

*Note: The following installation steps are based on the 2\*3 installation of PV modules, other installations may require the use of more accessories.*

#### Step 1. Fix Microinverter on the Rail

- A) Mark the approximate center of each panel on the frame.
- B) Fix the screw on the rail.

*Note: Install the microinverter with the silver side up and under the PV module. Allow a minimum of 2cm around the microinverter enclosure to ensure ventilation and heat dissipation.*

#### Step 2. Complete the AC Connection

- A) Attach the 3P-AC Bus Cable with the mounting rail, and fix the cable by tie wraps.

*Note: Minimize the distance between the microinverter and the 3P-AC bus connector for slack.*

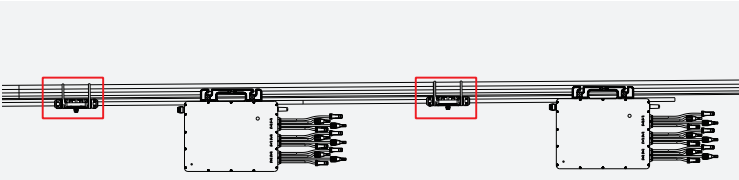

- B) Take the AC connector from the microinverter and push it into the 3P-AC bus connector until it clicks.

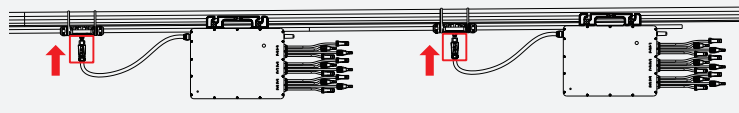

- C) If any bus port is vacant, please plug the 3P-AC sub cap into the port to protect it from dust and water.

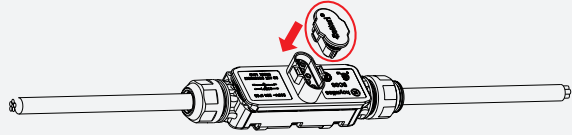

*Note: Under the circumstance that need to remove the inverter AC cable from 3P-AC bus connector, please use the 3P-AC connector unlock tool and insert the tool into the side of AC port to remove.*

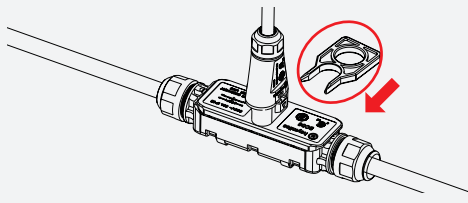

**Step 3. Install AC End Cable**

- A) Prepare the 3P-AC End Cable with the proper length, insert one side of the cable into the seal nut. Match the L1, L2, L3, N and Ground line into the slot accordingly. Tighten the screws, and then tighten the cap back to the connector. Plug the upper cover back to the 3P-AC bus connector.
- B) Connect the other side of the AC End Cable to the distribution box, and wire it to the local grid network.

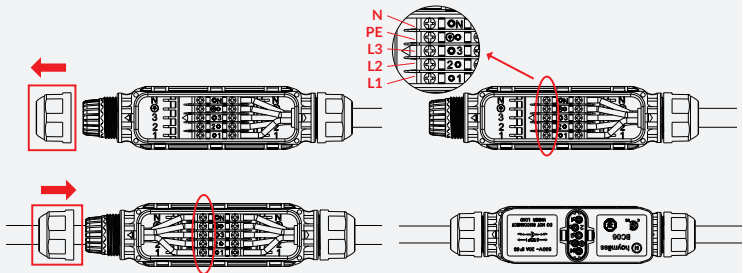

**Step 4. Create an Installation Map**

- A) Peel the removable serial number label from each microinverter (shown as picture).
- B) Affix the serial number label to the respective location on the installation map.

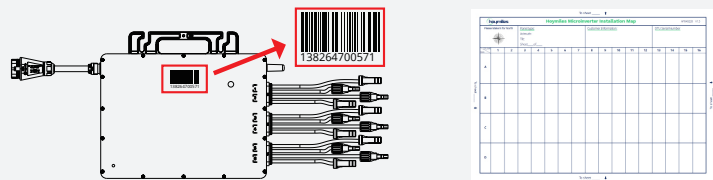

**Step 5. Connect PV Modules**

- A) Mount the PV modules above the microinverter.
- B) Connect the PV modules' DC cables to the DC input side of the microinverter.

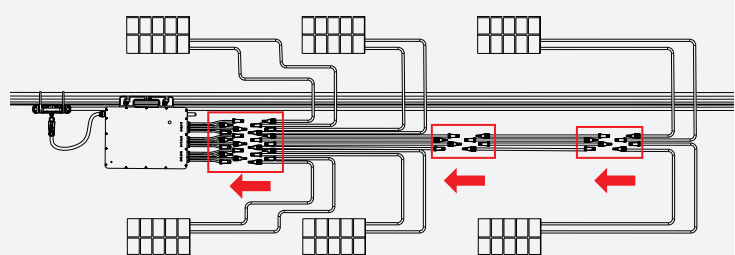

**Step 6. Energize the System**

- A) Turn on the AC breaker for the branch circuit.
- B) Turn on the main AC breaker for the house. The system will start to generate power after several minutes.

**Step 7. Monitoring System Set Up**

Refer to the DTU User Manual or DTU Quick Install Guide, and Quick Installation Guide for HMP Online Registration to install the DTU and set up monitoring system.

## 6. Troubleshooting

This microinverter (SN:1382xxxxxxx) can only work with the new Hoymiles DTU (DTU-Pro-S, DTU-Lite-S) with the following serial number.

Model	Serial Number
DTU-Pro-S	10FCxxxxxxx
	10FDxxxxxxx
DTU-Lite-S	10D7xxxxxxx
	10D8xxxxxxx

### 6.1 Troubleshooting List

Alarm Code	Alarm Name	Suggestion
121	Over temperature protection	<ol style="list-style-type: none"> <li>1. Check the ventilation and ambient temperature at the microinverter installation position.</li> <li>2. If the ventilation is poor or the ambient temperature exceeds the limit, improve the ventilation and heat dissipation.</li> <li>3. If both the ventilation and ambient temperature meet the requirements, contact your dealer or Hoymiles technical support.</li> </ol>
125	Grid configuration parameter error	<ol style="list-style-type: none"> <li>1. Check if the grid configuration parameter is correct and upgrade again.</li> <li>2. If the fault still exists, contact your dealer or Hoymiles technical support.</li> </ol>
126	Software error code 126	<ol style="list-style-type: none"> <li>1. If the alarm occurs accidentally and the microinverter can still work normally, no special treatment is required.</li> <li>2. If the alarm occurs frequently and cannot be recovered, contact your dealer or Hoymiles technical support.</li> </ol>
127	Firmware error	<ol style="list-style-type: none"> <li>1. Check if the firmware is correct and upgrade again.</li> <li>2. Check the communication between DTU and Hoymiles monitoring system, the communication between DTU and microinverter. Then try again.</li> <li>3. If the fault still exists, contact your dealer or Hoymiles technical support.</li> </ol>
128	Software error code 128	<ol style="list-style-type: none"> <li>1. If the alarm occurs accidentally and the microinverter can still work normally, no special treatment is required.</li> <li>2. If the alarm occurs frequently and cannot be recovered, contact your dealer or Hoymiles technical support.</li> </ol>
129	Software error code 129	<ol style="list-style-type: none"> <li>1. If the alarm occurs accidentally and the microinverter can still work normally, no special treatment is required.</li> <li>2. If the alarm occurs frequently and cannot be recovered, contact your dealer or Hoymiles technical support.</li> </ol>
130	Offline	<ol style="list-style-type: none"> <li>1. Please make sure that the microinverter works normally.</li> <li>2. Check the communication status between the DTU and hoymiles monitoring system or between the DTU and the microinverter. If the communication is poor, try to make some improvements.</li> <li>3. If the alarm occurs frequently and cannot be recovered, contact your dealer or Hoymiles technical support.</li> </ol>
141	Grid overvoltage	<ol style="list-style-type: none"> <li>1. If the alarm occurs accidentally, the grid voltage may be abnormal temporarily. The microinverter can recover automatically after grid voltage becomes normal.</li> <li>2. If the alarm occurs frequently, check whether the grid voltage is within the acceptable range. If no, contact the local power operator or change the grid overvoltage protection limit via Hoymiles monitoring system with the consent of the local power operator.</li> </ol>

142	10 min value grid overvoltage	<ol style="list-style-type: none"> <li>1. If the alarm occurs accidentally, the grid voltage may be abnormal temporarily. The microinverter can recover automatically after grid voltage becomes normal.</li> <li>2. If the alarm occurs frequently, check whether the grid voltage is within the acceptable range. If no, contact the local power operator or change the grid overvoltage protection limit via Hoymiles monitoring system with the consent of the local power operator.</li> </ol>
143	Grid undervoltage	<ol style="list-style-type: none"> <li>1. If the alarm occurs accidentally, the grid voltage may be abnormal temporarily. The microinverter can recover automatically after grid voltage becomes normal.</li> <li>2. If the alarm occurs frequently, check whether the grid voltage is within the acceptable range. If no, contact the local power operator or change the grid overvoltage protection limit via Hoymiles monitoring system with the consent of the local power operator.</li> </ol>
144	Grid overfrequency	<ol style="list-style-type: none"> <li>1. If the alarm occurs accidentally, the grid frequency may be abnormal temporarily. The microinverter can recover automatically after grid frequency becomes normal.</li> <li>2. If the alarm occurs frequently, check whether the grid frequency is within the acceptable range. If no, contact the local power operator or change the grid overfrequency protection limit via Hoymiles monitoring system with the consent of the local power operator.</li> </ol>
145	Grid underfrequency	<ol style="list-style-type: none"> <li>1. If the alarm occurs accidentally, the grid frequency may be abnormal temporarily. The microinverter can recover automatically after grid frequency becomes normal.</li> <li>2. If the alarm occurs frequently, check whether the grid frequency is within the acceptable range. If no, contact the local power operator or change the grid underfrequency protection limit via Hoymiles monitoring system with the consent of the local power operator.</li> </ol>
146	Rapid grid frequency change rate	<ol style="list-style-type: none"> <li>1. If the alarm occurs accidentally, the grid frequency may be abnormal temporarily. The microinverter can recover automatically after grid frequency becomes normal.</li> <li>2. If the alarm occurs frequently, check whether the grid frequency change rate is within the acceptable range. If no, contact the local power operator or change the grid frequency change rate limit via Hoymiles monitoring system with the consent of the local power operator.</li> </ol>
147	Power grid outage	Please check whether there is a power grid outage.
148	Grid disconnection	Please check whether the AC switch or AC wiring is normal.
149	Island detected	<ol style="list-style-type: none"> <li>1. If the alarm occurs accidentally, the grid voltage may be abnormal temporarily. The microinverter can recover automatically after grid voltage becomes normal.</li> <li>2. If the alarms occur frequently on all the microinverters in your station, contact the local power operator to check whether there is a grid island.</li> <li>3. If the alarm still exists, contact your dealer or Hoymiles technical support.</li> </ol>
171	Abnormal phase difference between phase to phase	Please check that the wiring of each phase is completely correct. This fault is usually caused by the wrong phase.
205	Input port 1&2 overvoltage	<ol style="list-style-type: none"> <li>1. Please make sure that the PV module open-circuit voltage is less than or equal to the maximum input voltage.</li> <li>2. If the PV module open-circuit voltage is within the normal range, contact your dealer or Hoymiles technical support.</li> </ol>

206	Input port 3&4 overvoltage	<ol style="list-style-type: none"> <li>1. Please make sure that the PV module open-circuit voltage is less than or equal to the maximum input voltage.</li> <li>2. If the PV module open-circuit voltage is within the normal range, contact your dealer or Hoymiles technical support.</li> </ol>
215	Input port 5&6 overvoltage	<ol style="list-style-type: none"> <li>1. Please make sure that the PV module open-circuit voltage is less than or equal to the maximum input voltage.</li> <li>2. If the PV module open-circuit voltage is within the normal range, contact your dealer or Hoymiles technical support.</li> </ol>
207	Input port 1&2 undervoltage	<ol style="list-style-type: none"> <li>1. Please make sure that the PV module open-circuit voltage is less than or equal to the maximum input voltage.</li> <li>2. If the PV module open-circuit voltage is within the normal range, contact your dealer or Hoymiles technical support.</li> </ol>
208	Input port 3&4 undervoltage	<ol style="list-style-type: none"> <li>1. Please make sure that the PV module open-circuit voltage is less than or equal to the maximum input voltage.</li> <li>2. If the PV module open-circuit voltage is within the normal range, contact your dealer or Hoymiles technical support.</li> </ol>
216	Input port 5&6 undervoltage	<ol style="list-style-type: none"> <li>1. Please make sure that the PV module open-circuit voltage is less than or equal to the maximum input voltage.</li> <li>2. If the PV module open-circuit voltage is within the normal range, contact your dealer or Hoymiles technical support.</li> </ol>
209	Port 1 No input	<ol style="list-style-type: none"> <li>1. Please confirm whether this port is connected to the PV module;</li> <li>2. If the PV module is connected, please check the DC cable connection between this port and the PV module.</li> </ol>
210	Port 2 No input	<ol style="list-style-type: none"> <li>1. Please confirm whether this port is connected to the PV module;</li> <li>2. If the PV module is connected, please check the DC cable connection between this port and the PV module.</li> </ol>
211	Port 3 No input	<ol style="list-style-type: none"> <li>1. Please confirm whether this port is connected to the PV module;</li> <li>2. If the PV module is connected, please check the DC cable connection between this port and the PV module.</li> </ol>
212	Port 4 No input	<ol style="list-style-type: none"> <li>1. Please confirm whether this port is connected to the PV module;</li> <li>2. If the PV module is connected, please check the DC cable connection between this port and the PV module.</li> </ol>
217	Port 5 No input	<ol style="list-style-type: none"> <li>1. Please confirm whether this port is connected to the PV module;</li> <li>2. If the PV module is connected, please check the DC cable connection between this port and the PV module.</li> </ol>
218	Port 6 No input	<ol style="list-style-type: none"> <li>1. Please confirm whether this port is connected to the PV module;</li> <li>2. If the PV module is connected, please check the DC cable connection between this port and the PV module.</li> </ol>
213	PV-1 & PV-2 abnormal wiring	Please check whether the DC connections on port 1 and 2 are correct.
214	PV-3 & PV-4 abnormal wiring	Please check whether the DC connections on port 3 and 4 are correct.
219	PV-5 & PV-6 abnormal wiring	Please check whether the DC connections on port 5 and 6 are correct.

221	Abnormal wiring of grid neutral line	Please confirm whether the grid neutral lines of the microinverters are connected to the neutral of the grid correctly.
301	Hardware Error Code 301	1. If the alarm occurs accidentally and the microinverter can still work normally, no special treatment is required. 2. If the alarm occurs frequently and cannot be recovered, contact your dealer or Hoymiles technical support.
302	Hardware Error Code 302	1. If the alarm occurs accidentally and the microinverter can still work normally, no special treatment is required. 2. If the alarm occurs frequently and cannot be recovered, contact your dealer or Hoymiles technical support.
303	Hardware Error Code 303	1. If the alarm occurs accidentally and the microinverter can still work normally, no special treatment is required. 2. If the alarm occurs frequently and cannot be recovered, contact your dealer or Hoymiles technical support.
304	Hardware Error Code 304	1. If the alarm occurs accidentally and the microinverter can still work normally, no special treatment is required. 2. If the alarm occurs frequently and cannot be recovered, contact your dealer or Hoymiles technical support.
305	Hardware Error Code 305	1. If the alarm occurs accidentally and the microinverter can still work normally, no special treatment is required. 2. If the alarm occurs frequently and cannot be recovered, contact your dealer or Hoymiles technical support.
306	Hardware Error Code 306	1. If the alarm occurs accidentally and the microinverter can still work normally, no special treatment is required. 2. If the alarm occurs frequently and cannot be recovered, contact your dealer or Hoymiles technical support.
307	Hardware Error Code 307	1. If the alarm occurs accidentally and the microinverter can still work normally, no special treatment is required. 2. If the alarm occurs frequently and cannot be recovered, contact your dealer or Hoymiles technical support.
308	Hardware Error Code 308	1. If the alarm occurs accidentally and the microinverter can still work normally, no special treatment is required. 2. If the alarm occurs frequently and cannot be recovered, contact your dealer or Hoymiles technical support.
309	Hardware Error Code 309	1. If the alarm occurs accidentally and the microinverter can still work normally, no special treatment is required. 2. If the alarm occurs frequently and cannot be recovered, contact your dealer or Hoymiles technical support.
310	Hardware Error Code 310	1. If the alarm occurs accidentally and the microinverter can still work normally, no special treatment is required. 2. If the alarm occurs frequently and cannot be recovered, contact your dealer or Hoymiles technical support.
311	Hardware Error Code 311	1. If the alarm occurs accidentally and the microinverter can still work normally, no special treatment is required. 2. If the alarm occurs frequently and cannot be recovered, contact your dealer or Hoymiles technical support.



## 6.2 Status LED Indicator

The LED flashes five times at start up. All green flashes (1s gap) indicate normal start up.

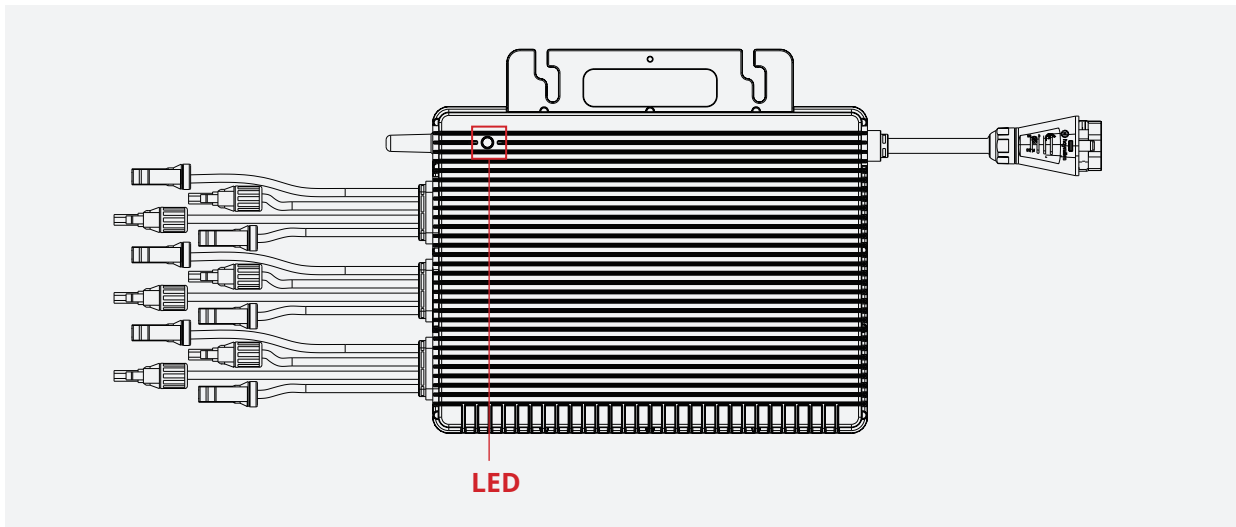

### (1) Start-up Process

- Flashing green five times (0.3s gap): Start-up success
- Flashing Red five times (0.3s gap): Start-up failure

### (2) Run Process

- Flashing Fast Green (1s gap): Producing power.
- Flashing Slow Green (2s gap): Producing power but one input is abnormal.
- Flashing Slow Green (4s gap): Producing power but there is no communication with DTU.
- Flashing Red (1s gap): Not producing power AC grid invalid (Voltage or frequency out of range).
- Flashing Red (0.5s gap): There is a fault except the abnormality of grid.

### (3) Other Status

- Flashing Red and Green alternately: Firmware is corrupted.







### 6.3 On-site Inspection (For qualified installer only)

To troubleshoot an inoperable microinverter, follow the steps in the order shown.

1	Verify the utility voltage and frequency are within ranges shown in the in appendix Technical Data of this microinverter.
2	Check the connection to the utility grid. Verify utility power is present at the inverter in question by removing AC, then DC power. Never disconnect the DC wires while the microinverter is producing power. Re-connect the DC module connectors and watch for five short LED flashes.
3	Check the AC branch circuit interconnection between all the microinverters. Verify each inverter is energized by the utility grid as described in the previous step.
4	Make sure that any AC breaker are functioning properly and are closed.
5	Check the DC connections between the microinverter and the PV module.
6	Verify the PV module DC voltage is within the allowable range shown in appendix Technical Data of this manual.
7	If the problem persists, please call Hoymiles customer support.
	<u>Do not try to repair the microinverter. If the troubleshooting fails, please return it to the factory for replacement.</u>

### 6.4 Routine Maintenance

1. Only authorized personnel are allowed to carry out the maintenance operations and are responsible to report any anomalies.
2. Always use the personal protective equipment provided by the employer when carry out the maintenance operation.
3. During normal operation, check that the environmental and logistic conditions are correct. Make sure that the conditions have not changed over time and that the equipment is not exposed to adverse weather conditions and has not been covered with foreign bodies.
4. DO NOT use the equipment if any problems are found, and restore the normal conditions after the fault removed.
5. Conduct an annual inspection on various components, and clean the equipment with a vacuum cleaner or special brushes.

	Do not attempt to dismantle the Microinverter or make any internal repairs! In order to preserving the integrity of safety and insulation, the Microinverters are not designed to allow internal repairs!
	The AC output wiring harness (AC drop cable on the Microinverter) cannot be replaced. If the cord is damaged the equipment should be scrapped.
	Maintenance operations must be carried out with the equipment disconnected from the grid (power switch open) and the photovoltaic modules obscured or isolated, unless otherwise indicated.
	For cleaning, do not use rags made of filamentary material or corrosive products that may corrode parts of the equipment or generate electrostatic charges.
	Avoid temporary repairs. All repairs should be carried out using only genuine spare parts.
	Each branch should provide a circuit breaker, but no need for central protection unit.

## 6.5 Replace Microinverter

<b>a. How to remove the Microinverter.</b>
<ul style="list-style-type: none"> <li>De-energize the AC branch circuit breaker.</li> </ul>
<ul style="list-style-type: none"> <li>Remove the PV panel from the racking, and cover the panel.</li> </ul>
<ul style="list-style-type: none"> <li>Using a meter to measure and make sure there is no current flowing in the DC wires between panel and microinverter.</li> </ul>
<ul style="list-style-type: none"> <li>Use the DC disconnect tool to remove the DC connectors.</li> </ul>
<ul style="list-style-type: none"> <li>Use the AC disconnect tool to remove the AC connectors.</li> </ul>
<ul style="list-style-type: none"> <li>Un-screw the fixing screw on the top of the microinverter and remove the microinverter from the PV racking.</li> </ul>
<b>b. How to replace the Microinverter:</b>
<ul style="list-style-type: none"> <li>Please record down the new Microinverter’s SN.</li> </ul>
<ul style="list-style-type: none"> <li>Please make sure the AC branch circuit breaker is off, and following the Microinverter installation steps to install the replacement unit.</li> </ul>
<ul style="list-style-type: none"> <li>Go to the monitoring platform (if customer already registers this station online), please access the “Device List” page and find the device that you just replaced. Please click the edit button on the right side of the page, and select “Device Replace”. Input the new Microinverter’s SN and click “OK” to complete the station changes.</li> </ul>

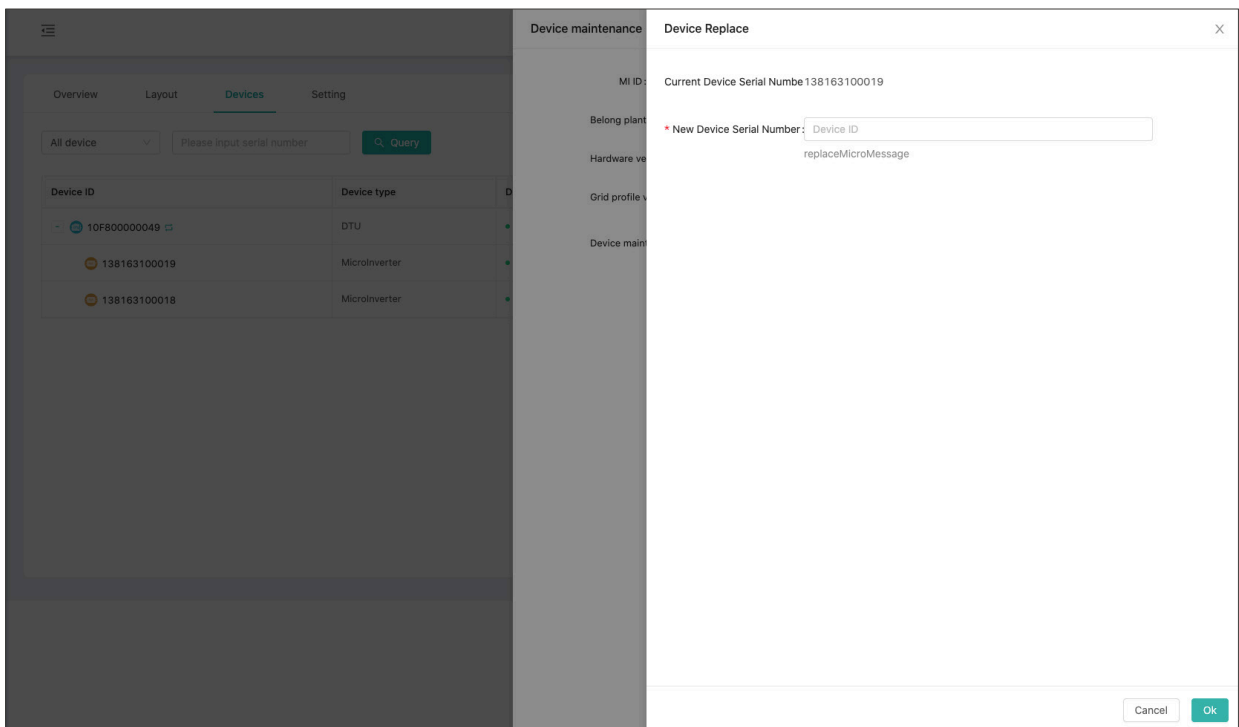

## 7. Decommissions

### 7.1 Decommissions

Disconnect the inverter from DC input and AC output; remove all connection cable from the Microinverter; remove the Microinverter from the frame.

Please pack the Microinverter with the original packaging, or use the carton box that can afford 5kg weight and can be fully closed if the original packaging is no longer available.

### 7.2 Storage and Transportation

Hoymiles packages and protects individual components using suitable means to make the transport and subsequent handling easier. Transportation of the equipment, especially by road, must be carried out by suitable ways for protecting the components (in particular, the electronic components) from violent, shocks, humidity, vibration, etc. Please dispose the packaging elements in appropriate ways to avoid unforeseen injury.

It is the customer's responsibility to examine the condition of the components transported. Once receiving the Microinverter, it is necessary to check the container for any external damage and verify receipt of all items. Call the delivering carrier immediately if damage or shortage is detected. If inspection reveals damage to the inverter, contact the supplier, or authorized distributor for a repair/return determination and instructions regarding the process.

The microinverter storage temperature is  $-40^{\circ}\text{C} \sim +85^{\circ}\text{C}$ .

### 7.3 Disposal

- If the equipment is not used immediately or is stored for long periods, check that it is correctly packed. The equipment must be stored in well-ventilated indoor areas that do not have characteristics that might damage the components of the equipment.
- Take a complete inspection when restarting after a long time or prolonged stop.
- Please dispose the equipment properly after scrapping, which are potentially harmful to the environment, in accordance with the regulations in force in the country of installation.

## 8. Technical Data

	Warning: Be sure to verify the following before installing Hoymiles Microinverter System.
	Verify that the voltage and current specifications of the PV module must match those of the microinverter.
	The maximum open circuit voltage rating of the PV module must within the operating voltage range of the microinverter.
	The maximum current rating at MPP is recommended to be equal to or less than the maximum input DC current. But the maximum short circuit current must be equal to or less than the maximum input DC short circuit current.
	The output DC power of PV module is NOT recommended to exceed 1.35 times the output AC power of the microinverter. Refer to "Hoymiles Warranty Terms & Conditions" for more information.

### 8.1 DC Input

Model	HMT-1800-6T	HMT-2250-6T
Commonly used module power (W)	Up to 405 (single panel)	Up to 505 (single panel)
MPPT voltage range (V)	16-60	16-60
Start-up voltage (V)	22	22
Maximum input voltage (V)	60	60
Maximum input current (A)	6 x 11.5	6 x 11.5
Maximum input short circuit current (A)	6 x 15	6 x 15
Number of MPPTs	3	
Number of Inputs per MPPT	2	
Maximum backfeed current to array (A)	0	

### 8.2 AC Output

Model	HMT-1800-6T	HMT-2250-6T
Grid connection	Three phase	
Rated output power (VA)	1800	2250
Rated output current (A)	3 x 2.73@220V 3 x 2.61@230V	3 x 3.41@220V 3 x 3.26@230V
Nominal output voltage (V)	220Vac/380Vac, 230Vac/400Vac, 3W+N+PE	
Nominal frequency (Hz)	50/60	
Power factor	>0.99 default 0.8 leading ... 0.8 lagging	
Output current harmonic distortion	<3%	<3%
Maximum units per 12AWG branch	7@220V 7@230V	5@220V 6@230V
Maximum units per 10AWG branch	11@220V 11@230V	8@220V 9@230V

### 8.3 Efficiency, Safety and Protection

Model	HMT-1800-6T	HMT-2250-6T
Peak efficiency	96.50%	96.50%
Nominal MPPT efficiency	99.80%	99.80%
Night time power consumption (mW)	<100	<100

### 8.4 Mechanical Data



Model	HMT-1800-6T	HMT-2250-6T
Ambient temperature range (°C)	-40 ~ +65	-40 ~ +65
Storage temperature range (°C)	-40 ~ +85	-40 ~ +85
Dimensions (W×H×D mm)	330 x 250 x 35	330 x 250 x 37
Weight (kg)	5.5	6.0
Enclosure rating	Outdoor-IP67	
Cooling	Natural convection – No fans	
Pollution degree	PD3	

### 8.5 Features

Model	HMT-1800-6T	HMT-2250-6T
Topology	High-Frequency Isolated Transformers	
Communication	Sub-1G	
Monitoring	S-Miles Cloud (Hoymiles DTU is required)	
Warranty	12 years standard, 25 years optional	
Compliance	VDE-AR-N 4105:2018, EN50549-1:2019, TOR Erzeuger: 2019-12, IEC/EN 62109-1/-2, IEC/EN 61000-3-2/-3, IEC/EN-61000-6-1/-2/-3/-4	

\*Note: Voltage and frequency ranges can be extended beyond nominal if required by the utility.

# Appendix 1: Installation Map

 <p>Please Make N for North</p> 		Panel type: _____		<p style="text-align: center;"><b>Hoy miles Microinverter Installation</b></p> <p>Customer Information: _____</p> <p>DTU Serial Number _____</p>												AP040228 V1.4																	
		Azimuth: _____														Tilt: _____																	
Sheet _____ of _____		1		2		3		4		5		6		7		8		9		10		11		12		13		14		15		16	
COLUMN		A		B		C		D																									
ROW																																	

To sheet \_\_\_\_\_ ↑

↑ To sheet \_\_\_\_\_

To sheet \_\_\_\_\_ ↓

To sheet \_\_\_\_\_ ↓

## Appendix 2:

### WIRING DIAGRAM – 230VAC / 400VAC THREE PHASE:

